

**CD Soundmachine**

AZ1220

**Meet Philips at the Internet**  
<http://www.audio.philips.com>

User manual  
Manuel d'utilisation  
Manual del usuario  
Benutzerhandücher

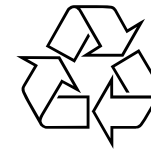

AZ 1220

**PHILIPS**



1

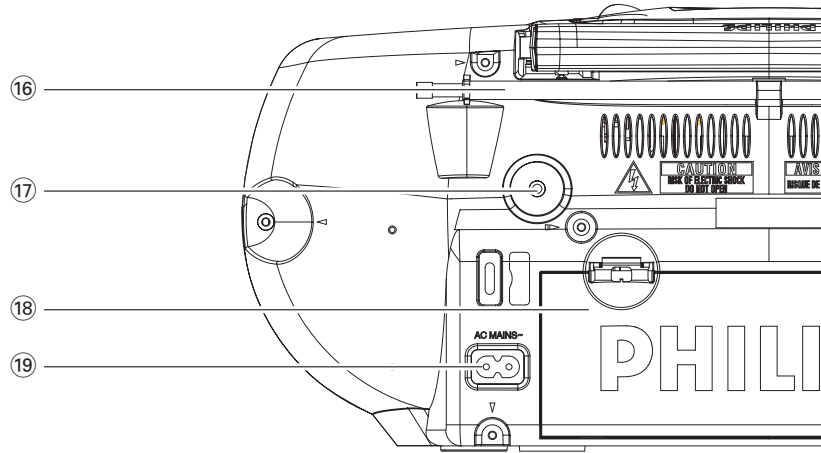
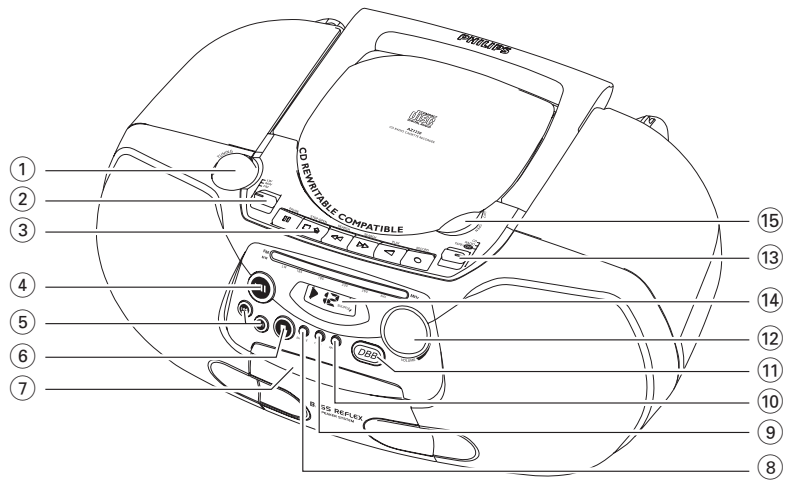

2



3



4

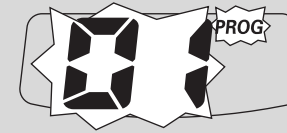

5



6



7

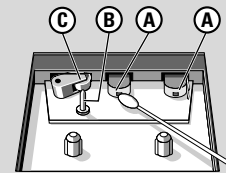
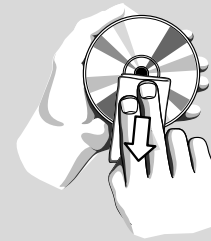
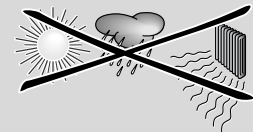

## English

## Controls

### Supplied accessories

AC power cord

### Top and front panels (See 1)

- ① **TUNING** – tunes to radio stations
- ② **Band selector: LW, MW, FM**  
– selects wavebands.
- ③ **Cassette recorder keys:**  
**II** – pauses playback or recording  
**■▲**  
– stops playback or recording.  
– opens the cassette holder.  
**◀▶** or **▶▶** – fast winds/rewinds the tape  
**◀** – starts playback  
**●** – starts recording
- ④ **▶II** - starts or pauses CD playback.
- ⑤ **SEARCH ◀▶▶▶** – CD: skips or searches a passage/track backward or forward.
- ⑥ **■** – stops CD playback;  
– erases a program;
- ⑦ **Cassette door**
- ⑧ **SHUFFLE** – plays all CD tracks in random order.
- ⑨ **PROG** – programs tracks and reviews the program
- ⑩ **REPEAT** – repeats a track/program/the entire CD.
- ⑪ **DBB (Dynamic Bass Boost)**  
– turns the bass enhancement on/off.
- ⑫ **VOLUME** – adjusts volume level
- ⑬ **CD Display** – shows CD functions

- ⑭ **Source selector : CD, RADIO, TAPE/OFF**  
– selects CD, radio or tape source of sound  
– switches off the set
- ⑮ **LIFT TO OPEN** – opens/closes the CD door

### Back panel

- ⑯ **Telescopic antenna** - improves FM reception.
- ⑰ **Headphone** - 3.5mm stereo headphone jack
- ⑱ **Battery door** - open to insert 6 x 1.5V **R-14/ UM2/ C-cells.**
- ⑲ **AC MAINS** - inlet for power cord.

### CAUTION

**Use of controls or adjustments or performance of procedures other than herein may result in hazardous radiation exposure or other unsafe operation.**

**This set complies with the radio interference requirements of the European Community.**

## Power Supply

### Power Supply

Whenever convenient, use the power supply cord if you want to conserve battery life. Make sure you remove the plug from the set and wall outlet before inserting batteries.

### Batteries (not included)

- 1 Open the battery compartment and insert six batteries, type **R-14, UM-2** or **C-cells**, (preferably alkaline) with the correct polarity as indicated by the "+" and "-" symbols inside the compartment.
- 2 Replace the compartment door; making sure the batteries are firmly and correctly in place. The set is now ready to operate.

**Batteries contain chemical substances, so they should be disposed of properly.**

- Incorrect use of batteries can cause electrolyte leakage and will corrode the compartment or cause the batteries to burst.
- Do not mix battery types: e.g. alkaline with carbon zinc. Only use batteries of the same type for the set.
- When inserting new batteries, do not try to mix old batteries with the new ones.
- Remove the batteries if the set is not to be used for a long time.

### Using AC power

- 1 Check if the power/mains voltage, **as shown on the type plate located on the bottom of the set**, corresponds to your local power supply. If it does not, consult your dealer or service center.

- 2 Connect the power cord to the AC POWER/MAINS inlet and the wall socket. The set is now ready for use.
- 3 To switch the set off completely, withdraw the power cord from the wall socket.
  - Disconnect the power cord from the wall socket to protect your set during heavy thunderstorms.

**The type plate is located on the bottom of the set.**

**For users in the U.K., please follow the boxed instructions 'Important notes...' on next page.**

### Helpful hints:

- To avoid unnecessary energy consumption, always adjust the **source selector** to **TAPE/OFF** after using the set. Also check that the tape deck keys are released.

## Basic functions

### Basic functions

#### Switching on/off the set:

- 1 To switch on, adjust the **source selector** to **CD**, **RADIO** or **TAPE/OFF** as desired.
- 2 To switch off, adjust the **source selector** to **TAPE/OFF** and check the cassette keys are released.

#### Adjusting volume and sound

Adjust the sound with the **VOLUME** and **DBB** (Dynamic Bass Boost) controls.

#### Selecting sources

Adjust the source selector to **CD**, **RADIO** or **TAPE/OFF** to select and toggle between sound sources.

## Tuner

### Radio reception

- 1 Push the **source selector** to **RADIO**.
- 2 Adjust the **band selector** to **LW**, **MW** or **FM** to select your desired waveband.
- 3 Turn **TUNING** to tune to a radio station.
- 4 To switch off the radio, adjust the **source selector** to **TAPE/OFF** and check the cassette keys are released.

#### Helpful hints:

##### To improve reception

- For **FM**, extend, incline and turn the telescopic antenna. Reduce its length if the signal is too strong.
- For **MW/LW**, uses a built-in antenna. Direct this antenna by turning the whole set.

## CD Player

### Playing a CD

This CD player plays Audio Discs including CD-Recordables and CD-Rewritables. Do not try to play a MP3 CD-ROM, CD-I, CDV, VCD, DVD or computer CD.

- 1 Adjust the **source selector** to **CD**.  
→ Display: - - flashes. (See [2])
- 2 To open the CD door, lift the CD door at the edge marked **LIFT TO OPEN**.
- 3 Insert a CD or CD-R(W) with the printed side facing up and press the CD door gently close.
- 4 Press **▶II** on the set to start playback.  
→ Display: ▶ and the current track number. (See [3])

#### To pause playback,

- Press **▶II**.  
→ Display: ▶ flashes.

#### To resume playback,

- Press **▶II** again.

#### To stop playback,

- Press **■**.

#### Helpful hints:

The CD playback will also stop when:

- you open the CD compartment;
- you select **RADIO** or **TAPE** sound source;
- the CD has reached the end of the playback.

### Selecting a different track

During playback,

- Briefly press **SEARCH** **◀◀** or **▶▶** once or repeatedly until you find your desired track.

During stop or pause,

- Press **▶II** to start playback after your desired track is selected.

### Finding a passage within a track

- 1 During playback, press and hold down **◀◀** or **▶▶**.  
→ The CD is played at high speed and low volume.
- 2 When you recognize the passage you want release **◀◀** or **▶▶**.  
→ Normal playback resumes.

#### Helpful hints:

- When your searching reaches the end of the last track, the CD playback stops.

## CD Player

### Programming tracks

You may store up to 20 tracks in the desired sequence. If you like, store any track more than once.

- 1 In the **STOP** position, press **PROG** to start programming.  
→ Display shows  $\overline{0}$  / indicating the start of the program. **PROG** and  $\overline{0}$  / flashes. (See [4](#))
- 2 Press **◀** or **▶** to select your desired track number.
- 3 Press **PROG** to store the desired track.  
→ Display shows  $\overline{0}$   $\overline{2}$  (up to  $\overline{2}$   $\overline{0}$  in sequence), indicating the next program location available.
- 4 Repeat steps **2** to **3** to select and store all desired tracks.
- 5 Press **▶||** to play the program.

### To review your program

In the stop position, press **PROG**  
→ The display shows all the stored tracks in sequence.

### Helpful hints:

- If you try to store more than 20 tracks, no track can be selected and the display will show all your stored tracks in sequence.
- If you press **PROG** and there is no track selected,  $\overline{0}$  / is displayed.

### To erase a program

You can erase a program by:  
– pressing **■** (twice during playback or once in the stop position);  
– selecting **RADIO** or **TAPE** sound source;  
– opening the CD door;  
→ Display: **PROG** disappears.

### Selecting different playing modes

During playback, you can select the playing modes by pressing **REPEAT** and **SHUFFLE** once or more.

 (**REPEAT** flashes) – plays the current track continuously. (See [5](#))

**REPEAT** – plays the entire CD/program continuously.

**SHUFFLE** – plays all tracks in random order.

**REPEAT SHUFFLE** – repeats the entire CD/program in random order. (See [6](#))

- To return to normal playback, press **REPEAT** or **SHUFFLE** until the REPEAT or SHUFFLE modes are no longer shown.

## Cassette Recorder

### Tape operation/recording

#### Playing a tape

- 1 Adjust the **source selector** to **TAPE/OFF**.
- 2 Press **■▲** to open the cassette holder; insert a cassette and close the deck.
- 3 Press **◀** to start playback.

#### To pause playback,

- Press **II**.

#### To resume playback,

- Press **II** again.

#### To stop playback,

- Press **■▲**.

### Helpful hints:

- The keys are automatically release at the end of the tape, and the set is switched off except if **II** has been activated.

### Fast forwarding/rewinding

- 1 Press **◀◀** or **▶▶** until you reach your desired passage.
- 2 Press **■▲** to stop rewinding/fast forwarding.

### General information on recording

- Recording is permissible insofar as copyright or other rights of third parties are not infringed.
- For recording, use only NORMAL type cassettes (IEC type I) on which the tabs have not yet been broken. This deck is not suited for recording on CHROME (IEC II) or METAL (IEC IV) type cassettes.
- The best recording level is set automatically. Altering the **VOLUME** and **DBB** controls will not affect the recording.
- To protect a tape from accidental erasure, break out the tabs. If you wish to record again, cover the tabs with a piece of adhesive tape.

### CD synchro start recording

- 1 Select **CD** source.
  - 2 Insert a CD and if desired, program track numbers.
  - 3 Press **■▲** to open the cassette holder: Insert a blank tape and close the deck.
  - 4 Press **●** to start recording.
- Playing of the CD programme starts automatically from the beginning of the programme. You don't need to start the CD player separately.

### To pause recording,

- Press **II**.

### To resume recording,

- Press **II** again.

### To stop recording,

- Press **■▲**.

## Cassette Recorder

### Recording from the Radio

- 1 Adjust the source selector to **LW**, **MW** or **FM** as desired.
- 2 Tune to a desired radio station (See **Radio reception**)
- 3 Follows steps 3-4, under **Recording from the CD**.

## Maintenance

### Precautions & General Maintenance (See [7])

- Place the set on a hard and flat surface so that the system does not tilt.
- Do not expose the set, batteries, CDs to humidity, rain, sand or excessive heat caused by heating equipment or direct sunlight.
- Do not cover the set. Adequate ventilation with a minimum gap of 6 inches between the ventilation holes and surrounding surfaces is necessary to prevent heat build-up.
- The mechanical parts of the set contain self-lubricating bearings and must not be oiled or lubricated.
- To clean the set, use a dry cloth. Do not use any cleaning agents containing alcohol, ammonia, benzene or abrasives as these may harm the housing.

### Tape deck maintenance (See [7])

To ensure quality recording and playback of the tape deck, clean parts (A), (B) and (C) as shown, once a month. Use a cotton bud slightly moistened with alcohol or a special head cleaning fluid to clean the deck.

- 1 Open the cassette holder by pressing ■▲.
- 2 Press ► and clean the roller (C).
- 3 Press II and clean the heads (A), and the capstan (B).
- 4 After cleaning, press ■▲.  
→ Cleaning of the heads can also be done by playing a cleaning cassette through once.

## Maintenance

### CD player and CD handling (See [7])

- If the CD player cannot read CDs correctly, use a cleaning CD to clean the lens before taking the set to repair.
- The lens of the CD player should never be touched!
- Sudden changes in the surrounding temperature can cause condensation on the lens of your CD player. Playing a CD is then not possible. Do not attempt to clean the lens but leave the set in a warm environment until the moisture evaporates.
- Always close the CD-tape door to avoid dust on the lens.
- To clean the CD, wipe in a straight line from the center towards the edge using a soft, lint-free cloth. Do not use cleaning agents as they may damage the disc.
- Never write on a CD or attach any stickers to it.

### Environmental information

All unnecessary packaging material has been omitted. The packaging can be easily separated into three materials: cardboard, polystyrene and plastic.

**Your set consists of materials which can be recycled if disassembled by a specialized company. Please observe the local regulations regarding the disposal of packaging, dead batteries and old equipment.**

## Troubleshooting

---

If a fault occurs, first check the points listed below before taking the set for repair.  
If you are unable to remedy a problem by following these hints, consult your dealer or service centre.

**WARNING:** *Do not open the set as there is a risk of electric shock. Under no circumstances should you try to repair the set yourself, as this will invalidate the guarantee.*

### Problem

---

#### No sound /power

---

- Volume not adjusted
- Adjust the VOLUME
- Power cord not securely connected
- Connect the AC power cord properly
- Batteries dead/ incorrectly inserted
- Insert (fresh) batteries correctly
- Headphones connected to the set
- Disconnect headphones
- CD contains non-audio files
- Press **SEARCH** ◀◀ or ▶▶ once or more skip the data file to a CD audio track

#### Display does not function properly/No reaction to operation of any of the controls

---

- Electrostatic discharge
- Switch off and unplug the set. Reconnect after a few seconds

#### 00 indication

---

- No CD inserted
- Insert a suitable disc
- CD badly scratched or dirty
- Replace/clean CD (See Maintenance)
- CD-R(W) is blank or the disc is not finalized.
- Use a finalized CD-R(W)
- Laser lens steam up
- Wait until lens has cleared

### The CD skips tracks

---

- CD damaged or dirty
- Replace or clean CD
- Shuffle or program is active
- Switch off shuffle/program

### Poor cassette sound quality

---

- Dust and dirt on the heads, etc.
- Clean deck parts, see Maintenance
- Use of incompatible cassette types (METAL or CHROME)
- Only use NORMAL (IEC I) for recording

### Recording does not work

---

- Cassette tab(s) may be broken
- Apply adhesive tape over the missing tab space

## Important notes for users in the U.K.

### Mains plug

This apparatus is fitted with an approved 13 Amp plug. To change a fuse in this type of plug proceed as follows:

1. Remove fuse cover and fuse.
2. Fix new fuse which should be a BS1362 5 Amp, A.S.T.A. or BSI approved type.
3. Refit the fuse cover:

If the fitted plug is not suitable for your socket outlets, it should be cut off and an appropriate plug fitted in its place. If the mains plug contains a fuse, this should have a value of 5 Amp. If a plug without a fuse is used, the fuse at the distribution board should not be greater than 5 Amp.

Note: The severed plug must be disposed of to avoid a possible shock hazard should it be inserted into a 13 Amp socket elsewhere.

### How to connect a plug

The wires in the mains lead are coloured with the following code: blue = neutral (N), brown = live (L). As these colours may not correspond with the colour markings identifying the terminals in your plug, proceed as follows:

- Connect the blue wire to the terminal marked N or coloured black.
- Connect the brown wire to the terminal marked L or coloured red.
- Do not connect either wire to the earth terminal in the plug, marked E (or e) or coloured green (or green and yellow).

Before replacing the plug cover, make certain that the cord grip is clamped over the sheath of the lead - not simply over the two wires.

### Copyright in the U.K.

Recording and playback of material may require consent. See Copyright Act 1956 and The Performer's Protection Acts 1958 to 1972.